



# A study on high speed tension property of C-grade bullet proof steel plate

Chinese Automotive Engineering Institute  
Co. Ltd

Ma Mingtu, Zhao Yan, Fang Gang, Feng Yi





- 1 Introduction**
- 2 Experimental method**
- 3 Experimental results**
- 4 Conclusion**



# 1. Introduction

## Strain rate sensitivity

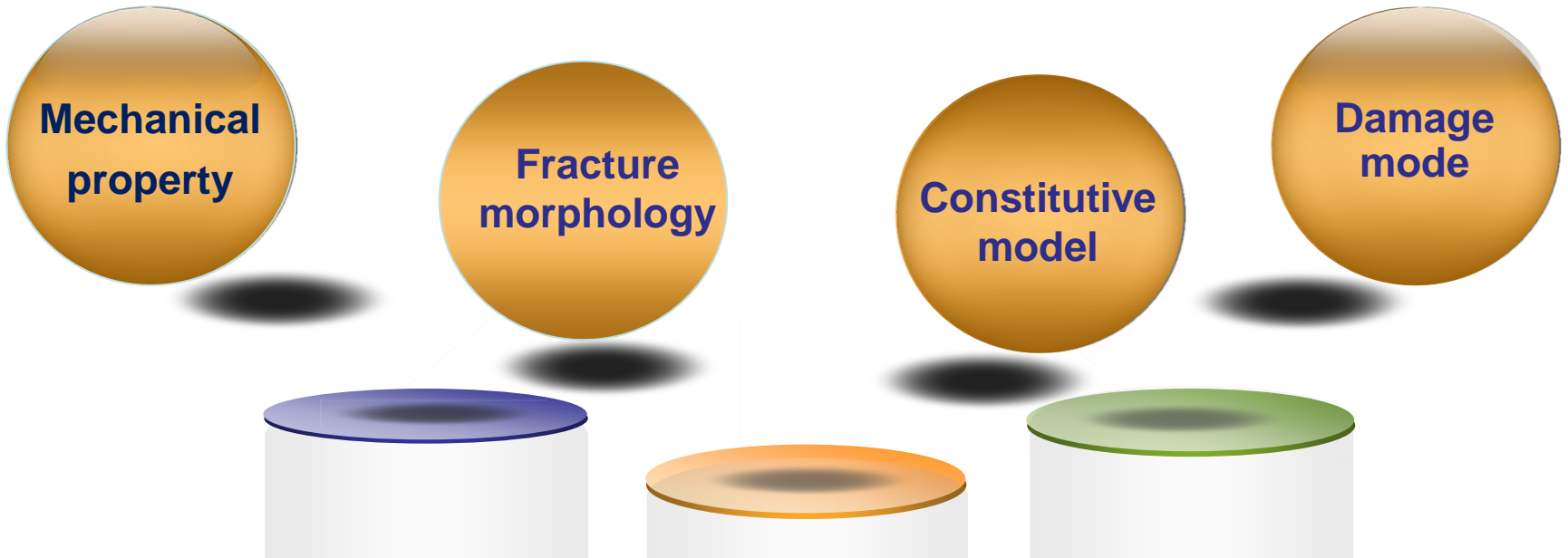

The actual materials deformation in impact process is dynamic for strain rate, thus high speed tension data are important for the accuracy of numerical simulation.



## 2. Experimental method

### Chemical compositions

Trademark	C	Si	Mn	P	S	Al	Nb+V+Ti	Cr+Ni	B
bullet proof steel level C	0.38~0.44	0.31~0.37	1.15~1.25	≤0.015	≤0.015	0.046	≥0.114	≥1.0	0.0016

### Hot stamping process

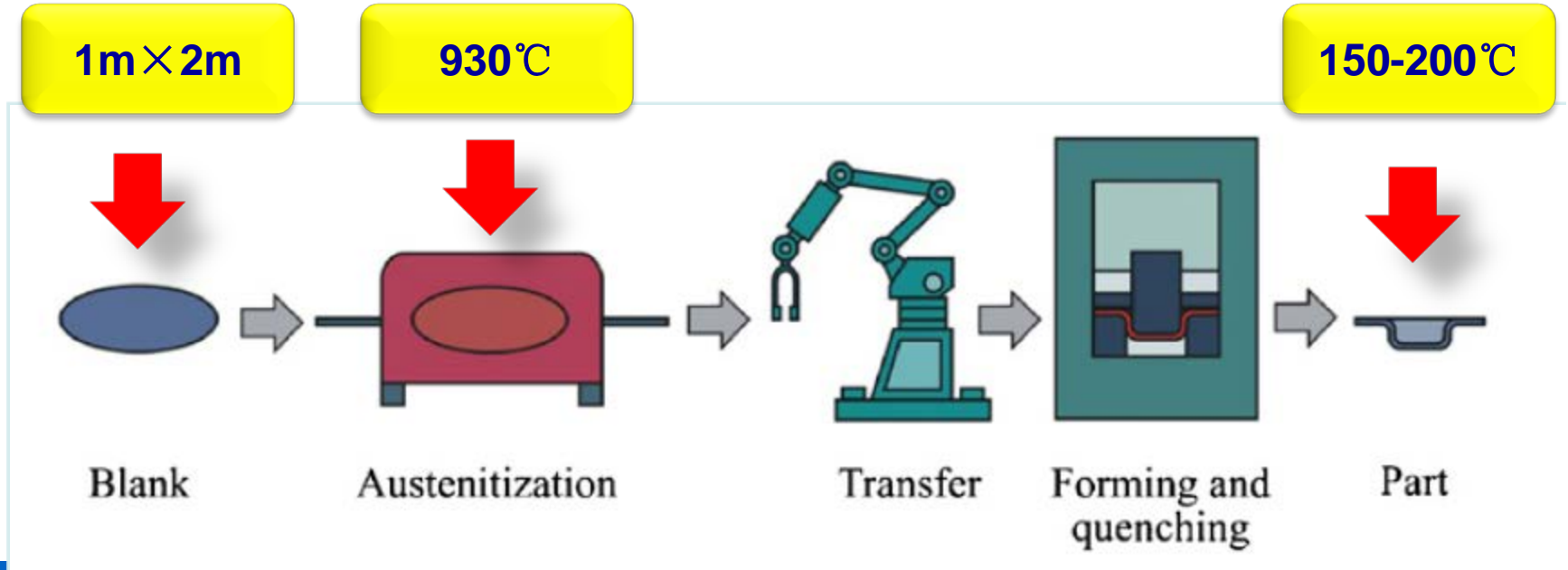

## 2. Experimental method

### Tension experiments at various strain rates

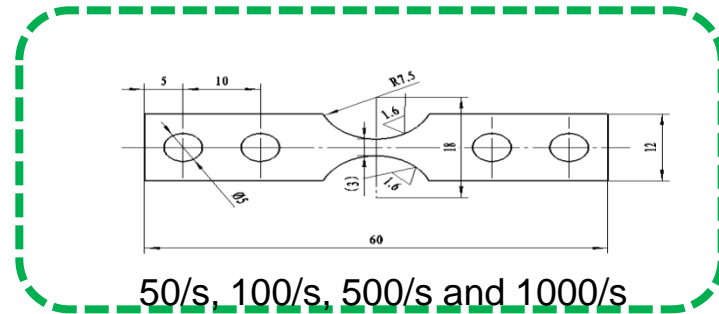
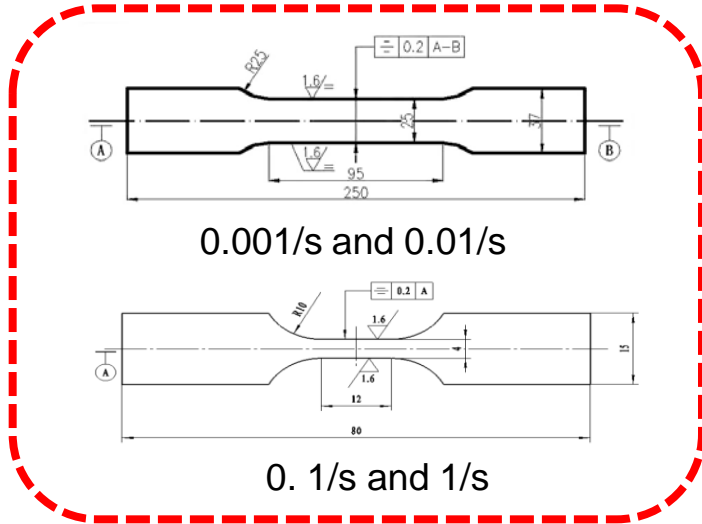

MTS-810  
tension tester



Zwick HTM5020

+



Hopkinson bar



# 3. Experimental results

Quasi-static data

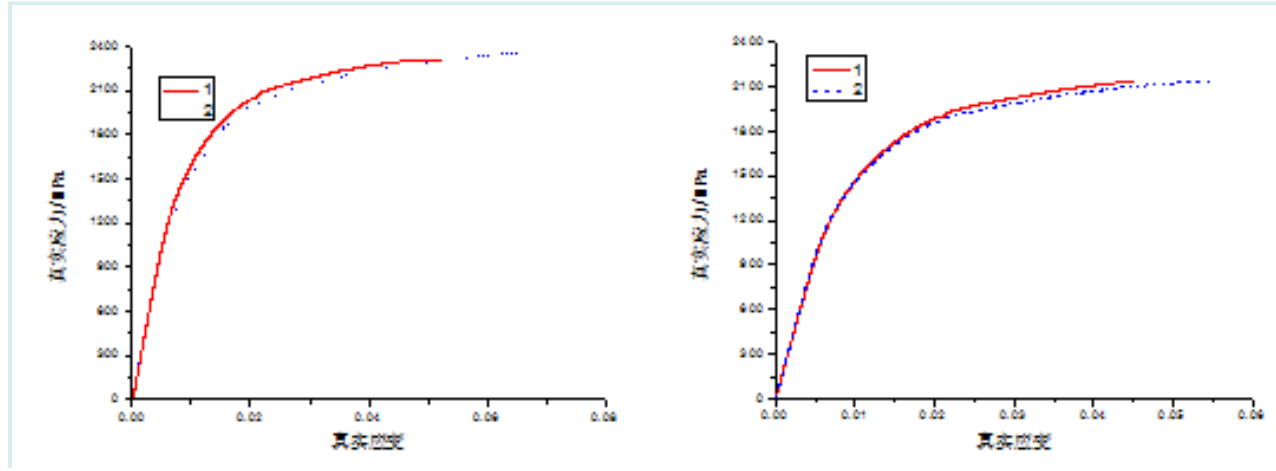

The true strain-stress curve at 0.001/s of C1

The true strain-stress curve at 0.001/s of C2

High speed data

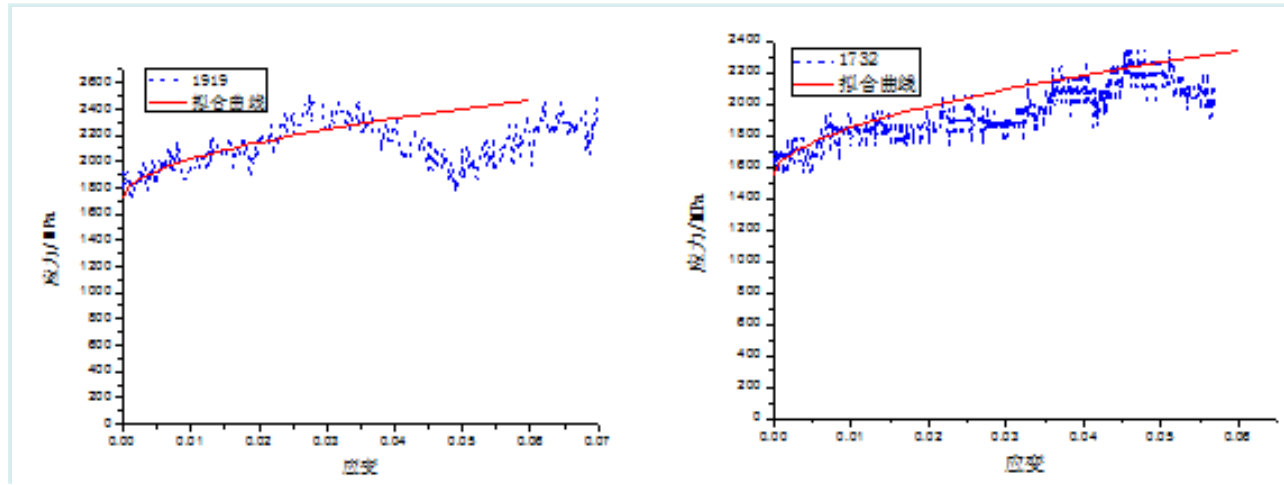

The true strain-stress curve at 1900/s of C1

The true strain-stress curve at 1700/s of C1



# 3. Experimental results

## Mechanical property

Serial number	Young modulus (GNm <sup>-2</sup> )	Yield strength (MPa)	Ultimate strengths (MPa)	Elongation (%)
C1	204	1515	2200	6.3
C2	197	1400	2035	5.2
R	206	1470	1775	5.8

## Bullet shooting results

Serial number	Shooting level	Test results	Thickness(mm)
C1	C	Not be Punctured	3.7
C2	C	Punctured	3.7
R	—	Not be punctured	4.0

# 3. Experimental results

## Fracture morphology at various strain rates

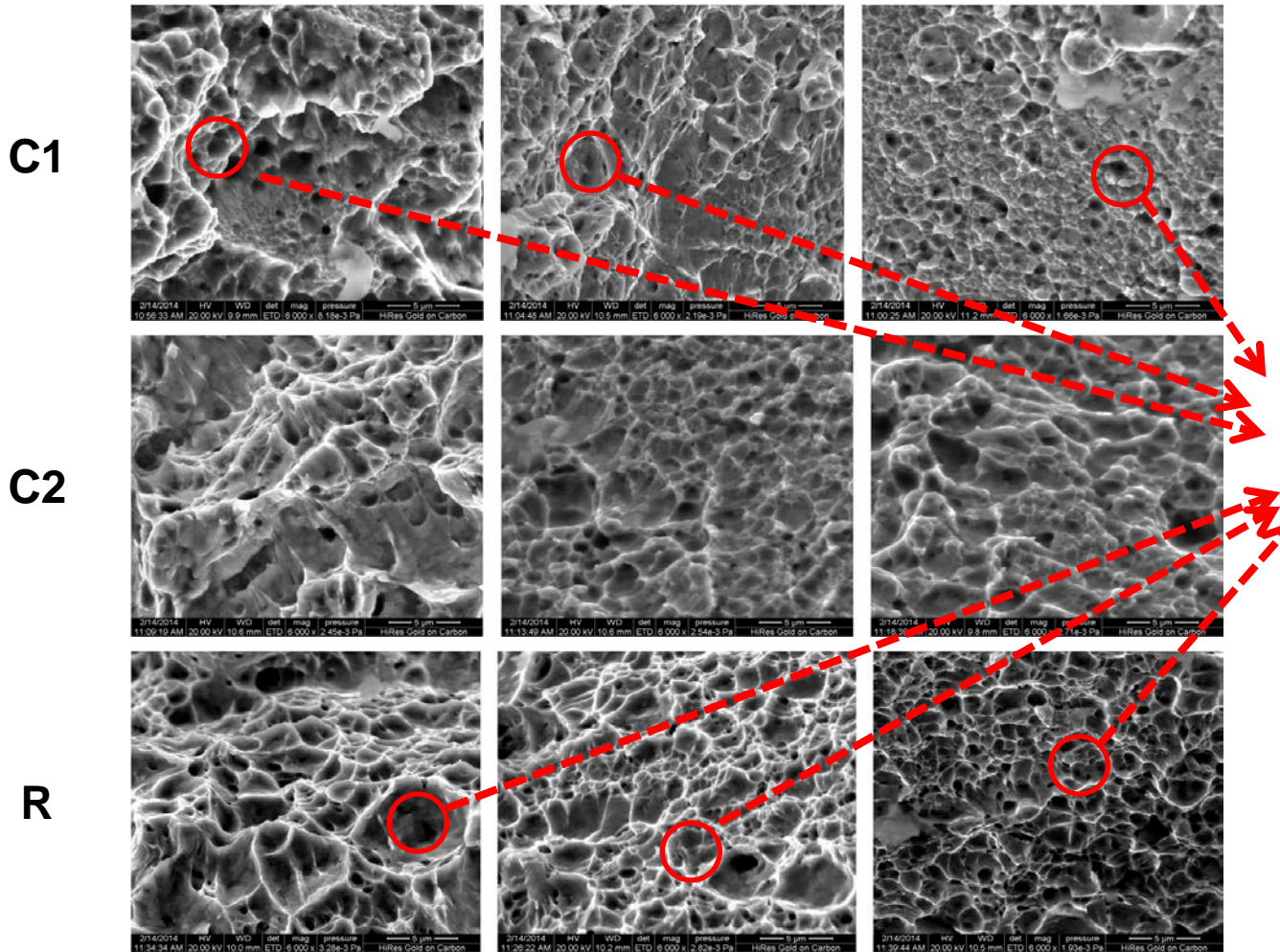

The depth of dimple decreases as the rising of strain rate.

This also means steels represent poor deformation capability at higher strain rate.





### 3. Experimental results

#### The constitutive equation of dynamic deformation

Johnson-Cook equation:

$$\sigma = (A + B\varepsilon^n) [1 + C \ln(\dot{\varepsilon} / \dot{\varepsilon}_0)]$$

Getting the values of A, n and B via quasi-static data (least square method)

$$n = \frac{\text{nodes} \times \sum [\ln \varepsilon \ln(\sigma - A)] - \sum \ln \varepsilon \sum \ln(\sigma - A)}{\text{nodes} \times \sum (\ln \varepsilon)^2 - (\sum \ln \varepsilon)^2}$$
$$\ln B = \frac{1}{\text{nodes}} (\sum \ln(\sigma - A) - n \sum \ln \varepsilon)$$

Getting the value of C via data at various strain rates (least square method)

$$C = \frac{\text{nodes} \times \sum [\ln(\dot{\varepsilon} / \dot{\varepsilon}_0) \ln(\frac{\sigma_s}{A + B\varepsilon_s^n})] - \sum \ln(\dot{\varepsilon} / \dot{\varepsilon}_0) \sum \ln(\frac{\sigma_s}{A + B\varepsilon_s^n})}{\text{nodes} \times \sum (\ln(\dot{\varepsilon} / \dot{\varepsilon}_0))^2 - (\sum \ln(\dot{\varepsilon} / \dot{\varepsilon}_0))^2}$$



# 3. Experimental results

The true strain-stress curves at various strain rates

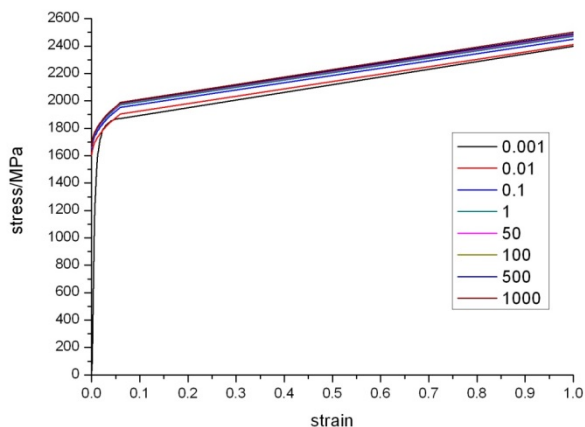
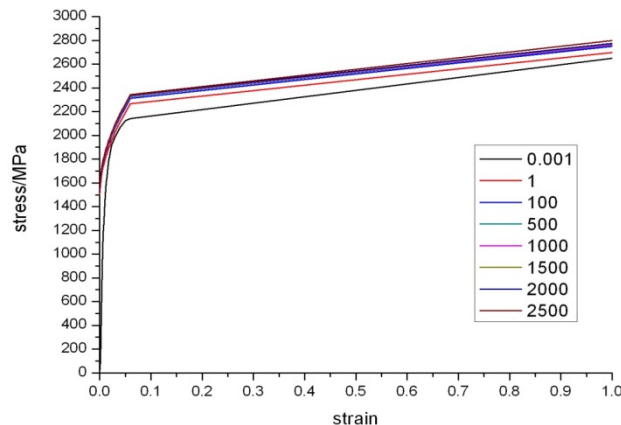
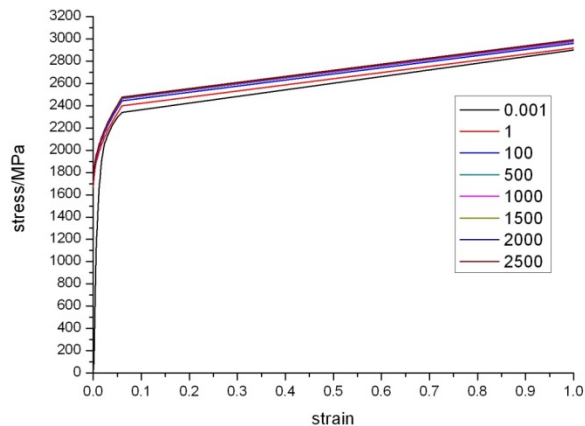

**C1:**

$$\sigma = (1670 + 3197 \varepsilon^{0.525}) \left( 1 + 0.00414 \ln \frac{\varepsilon}{\varepsilon_0} \right)$$

**C2:**

$$\sigma = (1500 + 3536 \varepsilon^{0.5437}) \left( 1 + 0.0043 \ln \frac{\varepsilon}{\varepsilon_0} \right)$$

**R:**

$$\sigma = (1600 + 1328 \varepsilon^{0.5238}) \left( 1 + 0.00572 \ln \frac{\varepsilon}{\varepsilon_0} \right)$$



## 4. Conclusion

- 1) The shoot-resistance capability of bullet proof steel is closely related to its strength, thickness and flow behaviors at various high strain rates. The shoot-resistance will be improved in the case of higher strength and better matching between strength and elongation.**
- 2) The Johnson-Cook equation fitted via experimental data provides fundamental data to numerical simulation.**
- 3) With the increase of strain rate, the size and depth of dimple trend to decrease and the depth of dimple for steel plate with lower strength and higher elongation changes less than that for steel plate with higher strength and slight lower elongation . The SEM analysis of fracture is benefit for further understanding of deformation and fracture mode under high strain rate.**



**Thanks for your kind attention!**